

ArenaMatch Utility AMU206

small-format foreground/fill loudspeaker

Product Overview

Built for zone-fill coverage or high-SPL foreground music, Bose Professional ArenaMatch Utility loudspeakers feature similar tonal balance to ArenaMatch array modules but in compact designs. They have the same EMB2S compression driver as ArenaMatch arrays, ensuring consistent sound, and the same direct-exposure outdoor weather rating. Deploy them for zone-fill coverage in sports stadiums, arenas, outdoor entertainment centers, and more. Or use them to provide intelligible, high-level sound in any outdoor area — from niche venues such as breweries and fairgrounds to larger settings like resorts and outdoor shopping centers.

The AMU206 is a small-format ArenaMatch Utility model for outdoor applications that require excellent audio from a compact loudspeaker. It provides wide, even coverage with a 120° × 60° constant-directivity high-frequency horn, 80 Hz – 18 kHz frequency response, 122 dB peak SPL, and supports the lowest vocal ranges with two Bose Professional LF6 6.5-inch woofers.

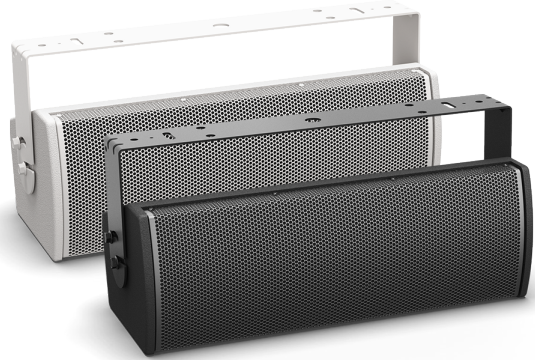

Key Features

Deploy as zone-fill to support ArenaMatch arrays systems, delivering powerful, intelligible sound and ensuring consistent tonal balance with EMB2S compression drivers in every speaker

Deploy to provide high-level foreground music in any outdoor venue

Install outdoors with an IP55 weather rating, three-layer stainless steel grille, water-resistant woofer cone coating, industrial polyurethane exterior coating, and molded cover to protect inputs

Adapt to a variety of configurations — all models ship standard with 70/100V transformer inputs and passive crossover with optimized filters for more consistent frequency and polar response

Streamline the design process by combining with complementary Bose Professional products, such as PowerMatch amplifiers and ControlSpace DSPs

Mount easily with included stainless-steel U-bracket; rear enclosure panel also includes M8 threaded inserts to accept third-party accessory mounting brackets

Provide wide, even coverage with 120° × 60° constant-directivity high-frequency horn, which can be rotated for horizontal or vertical installation

Perform in the most demanding applications with 80 Hz – 18 kHz frequency response and 122 dB maximum peak SPL

Support lowest vocal range with 2 × Bose Professional LF6 6.5-inch woofers featuring extended-excursion voice coil, which extends response to 80 Hz

EN 54-24 Certified: EN 54-24: 2008, Loudspeaker for Voice Alarm Systems for Fire Detection and Fire Alarm Systems for Buildings

ArenaMatch Utility AMU206

small-format foreground/fill loudspeaker

Technical Specifications

Single Module Performance				
Frequency Response (-3 dB) ¹	90 Hz to 16 kHz			
Frequency Range (-10 dB)	80 Hz to 18 kHz			
Nominal Coverage Pattern (H × V)	120° × 60° (rotatable high-frequency horn)			
Recommended High-pass Filter	80 Hz with minimum 12-dB / octave filter			
Crossover	Passive; separate bandpass filters per transducer (300 Hz and 1.5 kHz)			
70/100V transformer tap settings	70V: 5, 10, 20, 40, 80 W; 100V: 10, 20, 40, 80 W			
	Bose Professional Extended Lifecycle Test ²		AES Transducer Test ³	
Power Handling, long-term continuous	250 W		300 W	
Power Handling, peak	1000 W		1200 W	
	Free field	Wall/Ceiling	Free field	Wall/Ceiling
Sensitivity (SPL / 1W @ 1 m) ⁴	91 dB	93 dB	91 dB	93 dB
Calculated Maximum SPL @ 1 m ⁵	115 dB	117 dB	116 dB	118 dB
Calculated Maximum SPL @ 1 m, peak	121 dB	123 dB	122 dB	124 dB
Certifications				
EN 54-24 Certified	EN 54-24: 2008, Loudspeaker for Voice Alarm Systems for Fire Detection and Fire Alarm Systems for Buildings, refer to the ArenaMatch Utility small-format foreground/fill loudspeaker installation guide for specifications			
Transducers				
Low Frequency	2 × Bose Professional LF6 high-excursion 6.5-inch woofers (1.5-inch voice coil)			
High Frequency	1 × Bose Professional EMB2S extended high-frequency compression driver (2-inch voice coil)			
Nominal Impedance	8 Ω			
Physical				
Enclosure Material	Exterior-grade plywood			
Finish	Two-part spray polyurea coating, black or white			
Grille	3-layer: perforated stainless steel, acoustic foam, stainless steel mesh, powder-coat finish			
Environmental	Rated for direct-exposure outdoor installations (IP55 per EN60529; IP33C per EN 54-24)			
Connectors	1 × barrier strip, (accepts 10 to 18 wire gauge)			
Suspension/Mounting	2 × M8 threaded inserts for U-bracket; 4 × M8 threaded inserts on rear (127 × 70 mm, 4-bolt pattern)			
Dimensions (H × W × D)	191 × 553 × 268 mm (7.5 × 21.8 × 10.5 in) with input cover			
Net Weight	12.2 kg (26.8 lb) / 13.8 kg (30.5 lb) with u-bracket			
Shipping Weight	16.1 kg (35.5 lb)			
Accessories	Optional pan-and-tilt bracket			
Product Code				
Black	811435-0110			
White	811435-0210			

Footnotes

- (1) Frequency response and range measured on-axis in anechoic environment with recommended high-pass filter. Frequency response graphs display SPL axis with 0 dB line reference to sensitivity SPL value.
- (2) Bose Professional extended-lifecycle test using pink noise filtered to meet IEC268-5, 6-dB crest factor, 500-hour duration.
- (3) AES standard 2-hour duration with IEC system noise.
- (4) Sensitivity measured in anechoic environment with recommended bandpass and EQ.
- (5) Maximum SPL calculated using sensitivity and power ratings, exclusive of power compression.
- (6) Tested to IP55 per EN60529 when used in General Purpose Audio installation.

ArenaMatch Utility AMU206

small-format foreground/fill loudspeaker

Frequency Response

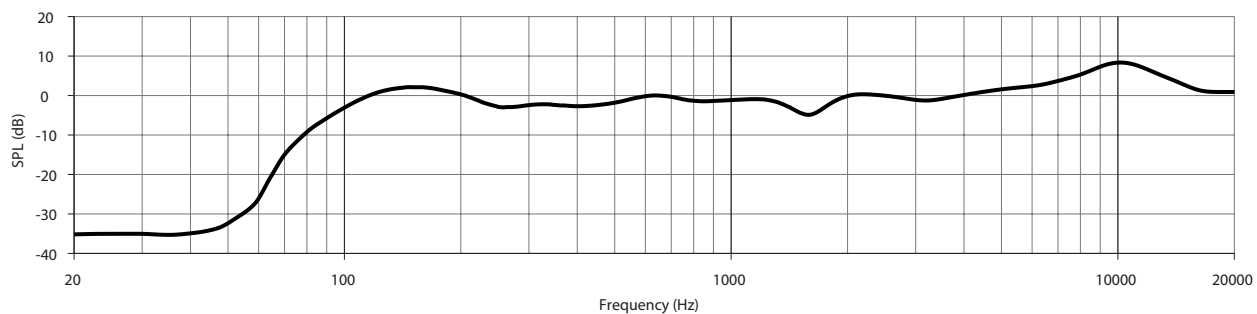

Beamwidth

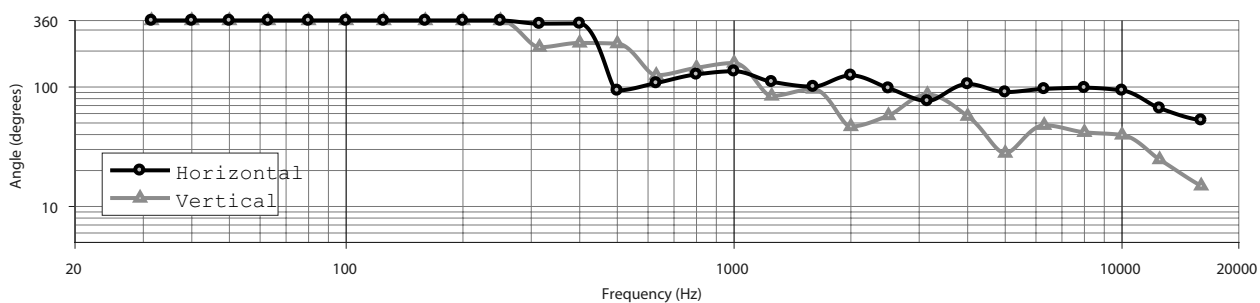

ArenaMatch Utility AMU206

small-format foreground/fill loudspeaker

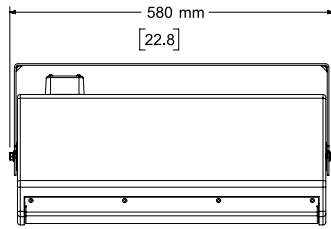

Top View

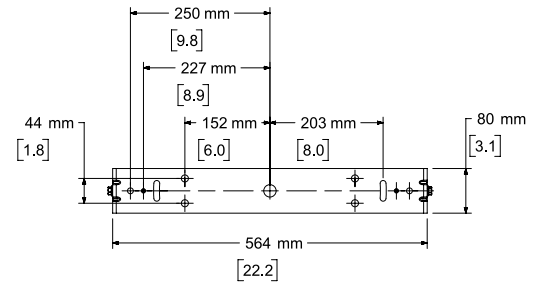
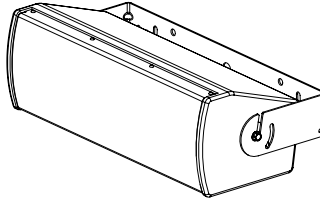

Rear View
BRACKET ONLY



Front View

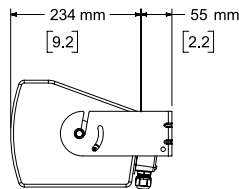

Right View
DIMENSIONS APPLY TO BOTH SIDES

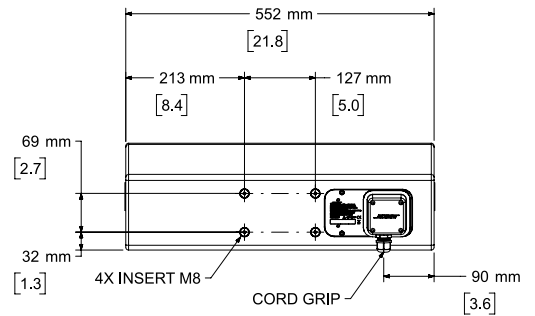

Rear View
BRACKET REMOVED FOR CLARITY

- NOTES:
 1. DIMENSIONS ARE IN MILLIMETERS OVER INCHES
 2. WEIGHT APPROX. 12.2kg [26.8lbs] (SPEAKER ONLY)
 WEIGHT W/BRACKET 13.8kg [30.5lbs]

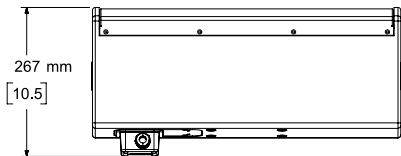

Bottom View
BRACKET REMOVED FOR CLARITY

© 2023 Transom Post OpCo LLC.

ArenaMatch, ControlSpace and PowerMatch are trademarks of Transom Post OpCo LLC. Bose is a trademark of Bose Corporation.

All other trademarks are the property of their respective owners.

For additional specifications and application information, please visit BOSEPROFESSIONAL.COM. Specifications subject to change without notice. 08/2023